



Operating and Maintenance Manual

ECO Line oil-less air compressors



4tek S.r.l.

Viale dell'Industria 66 - 20037 Paderno Dugnano (MI) ITALY
Tel. +39 02 91082211 - Internet: www.4-tek.it

ENGLISH translation of the original ITALIAN instructions

**Before using the compressor, read this document
carefully and keep it safe for future reference.**

Rev. 0 - 2023





Contents	Chapter/Page
List of Models and Technical Specifications	0 - 02
General information	
Foreword - Symbols used in the Manual - Important Warning	1 - 01
Contents and purpose of the manual - References to applicable Directives and Legislation	1 - 02
Operator skill requirements	1 - 03
CE plate	1 - 04
General notes on delivery - Final Testing - Preparatory work to be performed by the end-user	1 - 05
Description	
Description of the compressor and its component parts	2 - 01
Intended use - Reasonably foreseeable misuse	2 - 03
Noise level values - Operating and environmental conditions - permissible limits	2 - 04
Safety	
General information	3 - 01
Warning labels - Residual Risks	3 - 02
Installation	
Handling - Unpacking - Assembly	4 - 01
Electrical connection	4 - 02
Compressed air connection	4 - 03
Operation	
Basic operation rules	5 - 01
Fill times table	5 - 03
Automatic thermal protector - Reset button	5 - 04
Maintenance	
Safety precautions - Qualification of maintenance personnel	
Competences of qualified personnel - Specific safety precautions	6 - 01
Routine maintenance	6 - 03
Major servicing	6 - 04
Troubleshooting	6 - 06
Disposal	7 - 01
Warranty	8 - 01
How to order: spare parts	9 - 01
Exploded views and spare parts tables	9 - 02

List of Models and Technical Specifications



NOTE

The cross in the grey box shows the purchased Compressor Model.

Meaning of the symbols in the table on this page and on the following pages.



3-cylinder head



Twin head 3-cylinder



Triple head 3 cylinder



2-cylinder head



Twin head 2-cylinder

REF

Compressor model



Air receiver capacity



Dryer (Blue dot if present)



Dimensions in cm (W x D x H)



Weight in kg









































Noise level dB (A)















NOTE The electrical data are shown on the CE plate affixed to the compressor and reproduced on page 1- 04 of this document.

		REF	L		cm (W x D x H)	kg	dB (A)
<input type="checkbox"/>		ECO3N	25		48 x 48 x 63	41	70
<input type="checkbox"/>		ECO3E	25	●	48 x 50 x 63	46	70
<input type="checkbox"/>		ECO3N	40		48 x 46 x 81.5	48	70
<input type="checkbox"/>		ECO3E	40	●	48 x 60 x 81.5	53	70
<input type="checkbox"/>		ECO3N	50 V		48 x 46 x 88	50	70
<input type="checkbox"/>		ECO3E	50 V	●	48 x 60 x 88	55	70
<input type="checkbox"/>		ECO3N	50		40 x 75 x 75	50	70

		REF	 L		 cm (W x D x H)	 kg	 dB (A)
<input type="checkbox"/>		ECO3E	50	●	40 x 75 x 75	55	70
<input type="checkbox"/>		MONSTER3N	40		50 x 76.5 x 101.5	54	64
<input type="checkbox"/>		MONSTER3E	40	●	50 x 76.5 x 101.5	59	64
<input type="checkbox"/>		MONSTER3N	50		50 x 76.5 x 108	56	64
<input type="checkbox"/>		MONSTER3E	50	●	50 x 76.5 x 108	61	64
<input type="checkbox"/>		TOP3N	30		40 x 90 x 57	80	59
<input type="checkbox"/>		TOP3E	30	●	40 x 90 x 57	85	59
<input type="checkbox"/>		ECOSIL3N	50		50 x 92 x 82	90	54
<input type="checkbox"/>		ECOSIL3E	50	●	50 x 92 x 82	95	54
<input type="checkbox"/>		ECO6N	100		53 x 120 x 78	102	71
<input type="checkbox"/>		ECO6E	100	●	67 x 120 x 78	112	71
<input type="checkbox"/>		MONSTER6N	150		76.5 x 143 x 105	114	65
<input type="checkbox"/>		MONSTER6E	150	●	78 x 143 x 105	124	65
<input type="checkbox"/>		ECO9N	150		53 x 127 x 81	140	73

		REF	 L		 cm (W x D x H)	 kg	 dB (A)
<input type="checkbox"/>		ECO9E	150	●	55 x 127 x 81	150	73
<input type="checkbox"/>		ECO2N	25		48 x 48 x 63	38	68
<input type="checkbox"/>		ECO2E	25	●	48 x 50 x 63	43	68
<input type="checkbox"/>		ECO2N	40		48 x 46 x 81.5	45	68
<input type="checkbox"/>		ECO2E	40	●	48 x 60 x 81.5	50	68
<input type="checkbox"/>		ECO2N	50 V		48 x 46 x 88	47	68
<input type="checkbox"/>		ECO2E	50 V	●	48 x 60 x 88	52	68
<input type="checkbox"/>		ECO2N	50		40 x 75 x 75	47	68
<input type="checkbox"/>		ECO2E	50	●	40 x 75 x 75	52	68
<input type="checkbox"/>		MONSTER2N	40		50 x 76.5 x 101.5	51	62
<input type="checkbox"/>		MONSTER2E	40	●	50 x 76.5 x 101.5	56	62
<input type="checkbox"/>		MONSTER2N	50		50 x 76.5 x 108	53	62
<input type="checkbox"/>		MONSTER2E	50	●	50 x 76.5 x 108	58	62
<input type="checkbox"/>		TOP2N	30		40 x 90 x 57	77	57



		REF	 L		 cm (W x D x H)	 kg	 dB (A)
<input type="checkbox"/>		TOP2E	30	●	40 x 90 x 57	82	57
<input type="checkbox"/>		ECOSIL2N	50		50 x 92 x 82	87	52
<input type="checkbox"/>		ECOSIL2E	50	●	50 x 92 x 82	92	52
<input type="checkbox"/>		ECO4N	100		53 x 120 x 78	97	69
<input type="checkbox"/>		ECO4E	100	●	67 x 120 x 78	107	69
<input type="checkbox"/>		MONSTER4N	150		76.5 x 143 x 105	109	63
<input type="checkbox"/>		MONSTER4E	150	●	78 x 143 x 105	119	63



General information

Foreword

This manual will remain available for 10 years after the product to which it refers is discontinued.

The contents of this document cannot be used, reproduced or transferred to third parties without the express written permission of **4tek S.r.l.**



4tek S.r.l. reserves the right to change the specifications of the product to which this document refers, without notice.

The product meets the requirements of the **Medical Devices Regulation MDR (EU) 745/2017**.

Symbols used in the manual

This manual uses symbols to attract the reader's attention and highlight critically important sections.

The following table contains a list of the symbols used and illustrates their meanings.

SYMBOL	MEANING and NOTES
  	<p>CAUTION - General warning This indicates an important warning. Pay the utmost attention to text blocks marked with this symbol.</p> <p>WARNING - Mandatory information Text blocks containing information that it is mandatory to follow in every detail.</p> <p>NOTE - Additional information Text containing additional information is preceded by this symbol.</p>

IMPORTANT WARNING

This manual is an integral part of the product and it must remain with it throughout its entire life cycle until it is scrapped.

Authorised operators and maintenance technicians must be able to consult the manual at all times so it must be kept in a safe place near the equipment.



Contents and Purpose of the Manual

This manual contains technical specifications, performance details, transport and installation instructions, operating instructions and preventive and corrective maintenance operations of the equipment manufactured by **4tek S.r.l.**

Any change, addition, or removal of elements, components or functions of the equipment, unless agreed beforehand with **4tek S.r.l.**, will automatically relieve the manufacturer of all liability.

This manual, which is intended for the users of the equipment and technicians entrusted with its maintenance, provides the main technical data of the system, a technical description of the various functional units of which it is composed, as well as the main operating procedures and information needed to perform preventive and corrective maintenance operations.

The manual is addressed to persons with a sound knowledge of the manufacturing or processing method and is intended for the use both of operators and of service technicians.

This manual contains information on the equipment to ensure conditions of safety for all users and to guarantee perfect efficiency of the equipment throughout its entire working life.

To ensure correct use of the equipment, the workplace must be compliant with current health and safety regulations.

References to applicable directives and standards

EU Directives

Reference	Title
2014/35/EU	Low Voltage Directive
2017/745/EU	European Medical Devices Regulation
2014/29/EU	Simple Pressure Vessels Directive
2014/68/EU	Pressure Equipment Directive

EU Standards

Reference	Title
UNI EN ISO 14971	Medical Devices - Risk Management
CEI EN 60601-1-6	Medical electrical equipment. General requirements for basic safety and essential performance
CEI EN 60601-1-2	Electromagnetic compatibility
CEI EN 60601-1-6	Usability
CEI EN ISO 15223-1	Medical devices - Symbols to be used with medical device labels, labelling and information to be supplied - Part 1: General requirements
EN IEE 82079-1	Preparation of instructions for use - structuring, content and presentation



Operator skill requirements

Personnel responsible for running or servicing the equipment must be in possession of specific professional qualifications for each of the required tasks.

Operators must be suitably trained and therefore familiar with the tasks assigned to them and for which they are responsible.

The following is a description of the professional profiles required for personnel/operators entrusted to work with the equipment.



Operator

A qualified person capable of performing simple operating tasks and basic maintenance.



Maintenance Mechanic

A qualified technician capable of working on mechanical parts to perform all adjustment, maintenance, and repair tasks.



Maintenance Electrician

A qualified technician capable of performing all electrical adjustment, maintenance, and repair tasks.



Handling Operative

A person with specific skills in lifting techniques and equipment, slinging techniques and safe handling of loads.

Manufacturer's Maintenance Mechanic and Electrician



Qualified technicians can be provided by the manufacturer if necessary, to perform complex operations in special situations or in accordance with the agreements entered into with the user.

CE plate

Identification of **4tek S.r.l.** as the manufacturer of the equipment machine in compliance with the statutory legislation by means of the following deeds:



- ▶ **Instruction Manual**
- ▶ **CE marking (CE plate)**
- ▶ **Declaration of Conformity in compliance with Regulation (EU) 2017/745 (MDR)**

CE data plate description

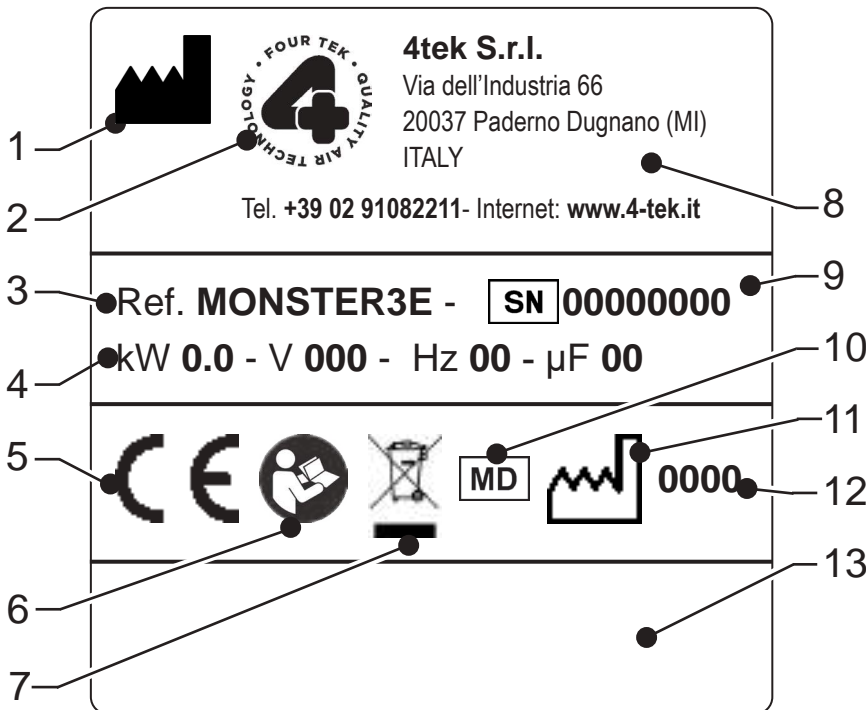

- 1 - Manufacturer's identification symbol
- 2 - Manufacturer's logo
- 3 - Compressor model
- 4 - Electrical technical data
- 5 - CE logo
- 6 - Symbol showing obligation to read the Instruction Manual
- 7 - Identification symbol for disposal of electrical and electronic components
- 8 - Manufacturer's contact details
- 9 - Serial number
- 10 - Medical Device identification symbol
- 11 - Manufacturing date identification symbol
- 12 - Year of manufacture
- 13 - UDI

The **CE plate** is affixed to the compressor and reproduced here alongside in the window.

It gives information related to the **CE mark**.

It is prohibited to remove the **CE plate** or replace it with plates from compressors of the same model in the possession of the user.

If the **CE plate** is damaged or becomes detached from the compressor, the user must inform **4tek S.r.l.**



NOTE

All equipment with more than one head must, in addition to the **CE Plate**, have an additional plate showing the serial number of each head.

Original **CE plate** affixed also to the compressor.



General notes on delivery

On receipt of the compressor, check that:

- ▶ The items supplied are in compliance with the order specifications.
- ▶ No damage has occurred in transit or due to other causes.



If you find any damage or missing parts, inform the shipping agent or **4tek S.r.l.** immediately, providing full details of the problem.

NOTE

When contacting 4tek s.r.l. or any of its service centres, always quote the serial number of the compressor.







Final Testing

The equipment is tested directly by the manufacturer during production in compliance with the company's quality system.

The equipment is supplied complete with a Declaration of Conformity for the product and its main components, i.e. the air receiver, the safety valve, and the dryer tank, if present.

4tek S.r.l. shall be held liable for the compressor in its original condition.

4tek S.r.l. shall not be held liable for improper use of the compressor and for any damage caused by failing to act in compliance with this manual or by acting unreasonably.

	4tek S.r.l. Via dell'Industria 66 20037 Paderno Dugnano (MI) ITALY Tel. +39 02 91082211- Internet: www.4tek.it					
Ref. MONSTER3E - SN 00000000 kW 0.0 - V 000 - Hz 00 - μ F 00						
						0000

Preparatory work to be performed by the end-user

Unless contractually agreed otherwise, the following are normally provided by the end-user:

- ▶ perfectly level non-slip floor with no irregularities;
- ▶ preparation of the place of installation;
- ▶ preparation of utilities suitable for the electrical system requirements;
- ▶ preparation of the electrical system in compliance with statutory legislation in force in the country of installation;
- ▶ equipment power supply matching the values shown on the data plate;
- ▶ ventilation and/or climate control to ensure temperature and humidity in the place of installation in compliance with the prescriptions given on page 2-04.

Description of the compressor and its component parts

The equipment is an oil-less compressor designed to supply compressed air for dental and/or medical applications.



Exploiting the rotation of the crankshaft, the pistons draw in air from the place where the compressor is installed via the air-intake filter, pressurise it, and transfer it to the air receiver for storage.

This operation is regulated by a pressure switch, which is typically set at between **6 bar** and **8.5 bar**; the process is ultimately controlled by the safety valve: if the pressure switch malfunctions and the air receiver pressure exceeds the safety valve setting, the valve will crack open to vent the overpressure and eliminate the risk of bursting.

- ▶ Class I appliance in relation to the new medical devices regulation **(MDR) 2017/745**
- ▶ The product is not designed to withstand immersion in liquid (IPX0)
- ▶ Class I: electrical insulation

Oil-less air compressor, 3-cylinder (ECO3E), 2-cylinder (ECO2E), applicable also to all the following models in the same product family.

- | | | |
|-------------|-------------|-------------|
| ▶ ECO3 | ▶ ECO9 | ▶ ECOSIL2 |
| ▶ MONSTER3 | ▶ ECO9E | ▶ ECOSIL2E |
| ▶ MONSTER3E | ▶ MONSTER6 | ▶ ECO4 |
| ▶ TOP3 | ▶ MONSTER6E | ▶ ECO4E |
| ▶ TOP3E | ▶ ECO2 | ▶ MONSTER4 |
| ▶ ECOSIL3 | ▶ MONSTER2 | ▶ MONSTER4E |
| ▶ ECOSIL3E | ▶ MONSTER2E | |
| ▶ ECO6 | ▶ TOP2 | |
| ▶ ECO6E | ▶ TOP2E | |

ECO3E compressor composed of:

- ▶ 3-cylinder head, equipped with single-phase or three-phase motor, characterised by an air inlet of **300 l/min**, air delivery at **5 bar 225 l/min**
- ▶ 1 air receiver capacity: **50 l**

ECO2E compressor composed of:

- ▶ 2-cylinder head, equipped with single-phase or three-phase motor, characterised by an air inlet of **200 l/min**, air delivery at **5 bar 150 l/min**
- ▶ 1 air receiver capacity: **50 l**

Available also in the following versions:

- ▶ **25 l** air receiver
- ▶ **40 l** vertical air receiver
- ▶ **50 l** vertical air receiver

All models are available also without a dryer.

If the device is enclosed in a cabinet, it will be equipped with a cooling fan and associated control thermostat.



- ▶ Mechanical **pressure switch** [230 V versions] (Fig. 1)
- ▶ Mechanical **pressure switch** [MDR3 - 400V three-phase versions] (Fig. 2)
- ▶ Mechanical **pressure switch** [MDR5 - 400V three-phase versions] (Fig. 3)
- ▶ Safety **valve** (Fig. 4)
- ▶ Non-return **valve** [For compressors with dryer] (Fig. 5)



- ▶ **Dryer** [Only if model is identified with letter "E"] (Fig. 6)
- ▶ 3-way non-return **valve** (Fig. 7) [For compressors without dryer]
- ▶ 2-way N.O. 1/8" **solenoid valve** (Fig. 8)
- ▶ **Pressure gauge** [Only for TOP Line versions] (Fig. 9)
- ▶ **Pressure gauge** [All other versions] (Fig. 10)
- ▶ **Miscellaneous fittings**
- ▶ **Miscellaneous accessories**
Pressure reducer with pressure gauge (Fig. 11)





Intended use

The products are designed to supply compressed air to dental surgeries and orthodontic laboratories; they are normally installed in a plant room or anyway an area separated from the operating area.

Reasonably foreseeable misuse

Any work process not classified as intended use is deemed to be improper use of the compressor and could result in damage to property and/or injury to persons.

The compressor cannot be used:

- **Outdoors in an area directly exposed to the weather**
- **In areas exposed to corrosive and/or abrasive vapour, fumes, or dust**

Also the following are examples of improper use:

- **The instinctive reaction of persons in the event of a malfunction, accident, or fault during use of the compressor**
- **Behaviour resulting from distraction or carelessness**
- **Behaviour resulting from external pressure to keep the compressor running in all circumstances**
- **Behaviour of certain people (e.g. untrained personnel)**
- **Failure to read the compressor Instruction Manual, entirely or in part.**



CAUTION!!!

The compressor is NOT suitable for use in potentially explosive atmospheres.



Noise level values

- A-weighted equivalent sound pressure **below 80 dB (A)**
- C-weighted maximum instantaneous sound pressure **< 130 dB**
- K correction factor

The stated noise values are emission levels and are not necessarily safe operating levels.

Even though there is a relationship between emission levels and exposure levels, this cannot be used to reliably establish the need for further precautions.

The factors that determine the noise levels to which the workforce is exposed include duration of exposure, workplace characteristics, other noise sources, etc.

Legally allowed exposure levels may vary from country to country.

In any case, this information will allow the compressor user to better assess the noise hazard and risk.



CAUTION

In zones with noise level > 85 dB, the operator must use suitable personal protective equipment such as ear defenders or ear plugs.



Operating and environmental conditions - permissible limits

Although the compressor is designed for use only indoors, cabinet enclosed versions can also be installed outdoors.

In order to ensure trouble-free operation in conditions of complete safety, the following parameters must be observed:

- Operating temperature: **0 °C to +40 °C**
- Maximum relative humidity: **80%** for temperatures above **31 °C** falling to **50%** for temperatures above **40 °C**.
- Power supply tolerance: **+/- 10%**
- Pollution level: **2**

Safety**CAUTION**

Do not use the compressor if the power cable or plug are damaged.



- If the compressor is not working correctly, if it has suffered impact, is damaged, or has come into contact with water or other liquids: contact technical service to have it checked over and/or repaired.
- Do not use the product if it is exposed to the rain or high humidity levels.
- Keep the power cable well clear of hot surfaces.
All electrical connections can produce heat.
- To avoid burns, NEVER touch the compressor while it is running or immediately after it has been shut down.
The compressor outer surface can reach temperatures of up to 120°C.
- Do not obstruct the cylinder head or electric motor fan grilles; obstructing the grilles prevents compressor ventilation leading to overheating and possible fire risks.
- Use the compressor only in well ventilated places.
- Do not insert fingers or objects in the compressor air intake grilles.
- Protect the compressor from contaminants and dirt.
- Do not dismantle the compressor.
Incorrect compressor disassembly or reassembly can cause electric shock and/or serious damage to property or injury to persons in the vicinity of the compressor.
Have the work performed by a specialised service centre/qualified technician.
- Maintenance work must be carried out by qualified technicians.
- Do not touch the compressor with wet hands.
Unplug the power cable immediately.
- To reduce fire or explosion risks, do not use the equipment near explosive substances or in areas subject to the presence of explosive gas.
- Do not use the equipment near open flames.
- Tampering or unauthorised replacement of one or more parts of the compressor and the use of accessories that change its operation can result in an injury risk.
The employer must inform its personnel of all injury risks.
- **Mandatory notification of serious incidents.**
The user and/or patient must inform the manufacturer and the competent authority in the member state in which they reside of any serious incidents concerning the product.
- **Mandatory guarantee of product traceability.**
All economic operators are required to guarantee product traceability throughout the entire distribution chain.

Warning Decals

The compressor bears safety and warning labels with the following information. The symbol codes refer to **UNI CEI EN ISO 15223-1** and **ISO 7010**.

Danger



Triangular shape with black images on yellow background and black border.

Mandatory signs



Circular shape with white images on blue background.



Warning; Electricity
Code **W012**



Warning; Hot surface
Code **W017**



Mandatory sign:
Check guard
Code **M027**



Mandatory sign:
Refer to instruction
manual/booklet
Code **M002**



CAUTION

Operators and Maintenance technicians must comply strictly with all the warnings shown by the safety symbols.

It is strictly forbidden to interfere with or remove these labels.

Residual Risks

Residual risk of electrical shock



This risk arises if work must be carried out on the compressor with power connected.



Work of this kind must be carried out only by qualified Maintenance electricians.

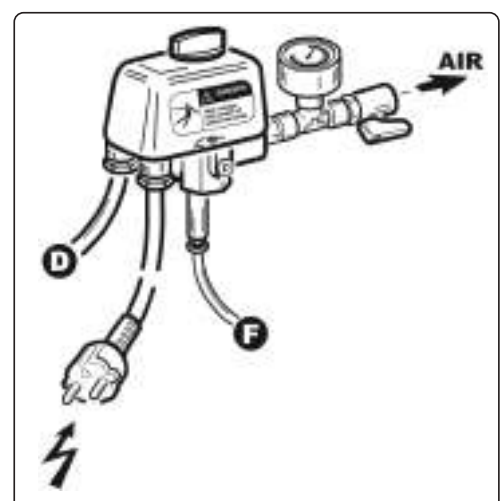

Residual risk of burns

There is a residual risk of burns associated with contact with the zone shown in Figures 1 and 2.



In case of checks carried out on the compressor and/or maintenance operations, it is **MANDATORY** to wear protective gloves.

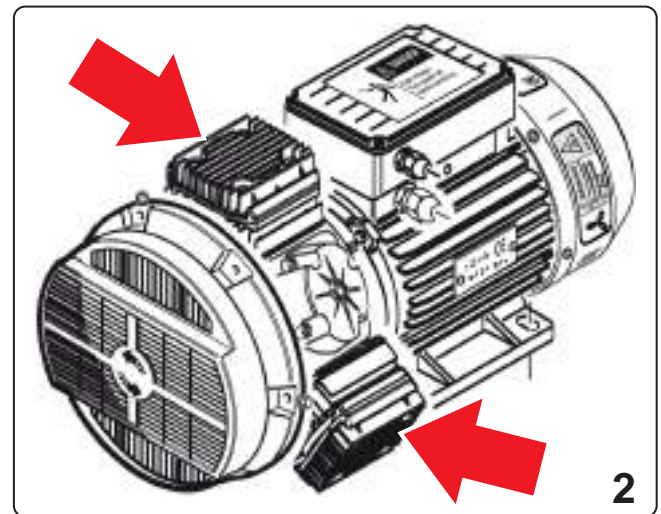
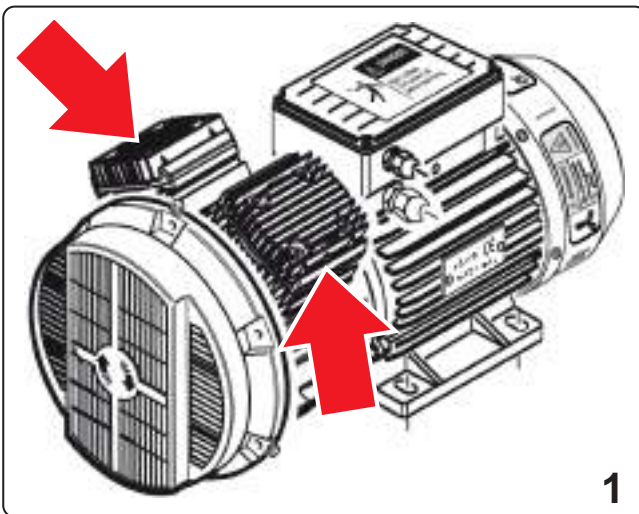

Installation

Handling



The entire area in which the compressor is handled, including the transport vehicle parking area and the area designated for installation of the compressor, must be specified and inspected beforehand in order to allow the identification of “**DANGER ZONES**”.



Personal protective equipment

- All compressors are shipped on a pallet that can be handled by a forklift or pallet truck. Except for the smallest models, all other compressors must be moved using suitable handling equipment.
- Take care during handling, lifting and transport to prevent damage to the compressor or other property and personal injury.
- Check the weight of the compressor and use a forklift truck or suitable lifting equipment.
- When lifting the compressor use caution to avoid damage.
- While transporting the compressor lash securely it to the vehicle both crosswise and lengthwise.
- Packs of the same weight can be stacked up to three high.

Unpacking

- Remove the compressor from the pack carefully.
- Keep the pack for possible future shipping requirements.
If the pack shows signs of damage, sign the shipping agent's delivery note under reservation and keep the pack for possible inspection by the transport company.
If you need to contact the distributor or the manufacturer, always quote the compressor serial number to aid rapid identification.
The equipment serial number is always transcribed on the transport document.



Assembly

- Install the compressor indoors or anyway in a place where it is not directly exposed to the weather.
The room in which the compressor is installed must be well ventilated and not damp; if the compressor is installed in a plant room air circulation must be sufficient for all the equipment installed; ambient temperature must be no higher than 40°C and no lower than 0°C.
- The product feet are fitted with rubber vacuum cups. These are essential because they reduce vibration and thus help to reduce the noise level while also limiting any movement of the unit while it is running.



Most models are equipped with handles so they can be safely lifted.

The compressor should be installed in a clean environment.

We recommend creating the compressed air circuit with a classic “ring” type circuit using **Rilsan Pa12** tubing (or an equivalent type of plastic compressed air tubing); specifically:

- Main line: **Ext. D 18 mm**
- Secondary line / connection between ring and dental chair: **Ext. D 14 mm**



Electrical connection

The main connections must be made by specialized technicians. To guarantee correct installation, check the current and voltage value of the building electrical supply. Connecting the compressor to an electrical supply with the incorrect voltage can cause serious damage.



CAUTION

Do not replace the electrical power cable if not expressly authorised by the supplier or by an authorised installer: replacing the cable could lead to interference with other nearby equipment and/or faults.

Beware of the risk of electric shock!

- Disconnect the power at the main disconnect switch before connecting the compressor.
- Install the equipment in a place where it cannot come into contact with water or other liquids.
- Make sure the electrical power line is sufficient for the compressor, following the data shown on the motor rating plate.



Failure to comply with these instructions could lead to death, fire, or electrocution.

Compressed air connection

- Connect the compressor to the compressed air circuit with **min Ø 6 x 8 Rilsan** tubing. Pay the utmost attention to the tubing route because condensate may form over long distances due to possible temperature differences.

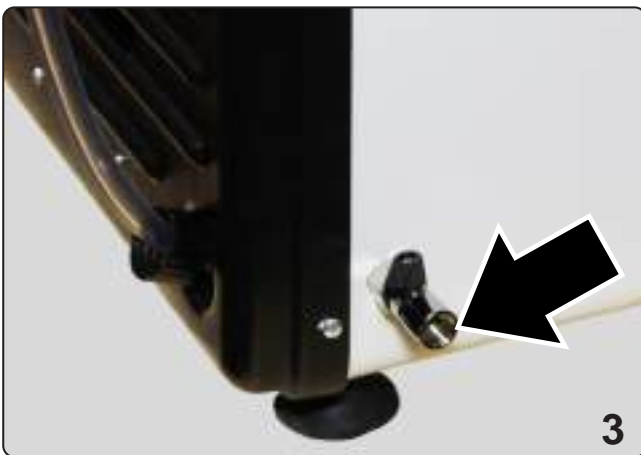
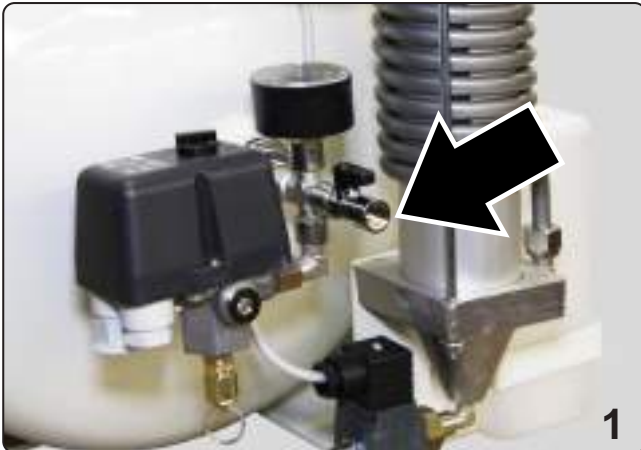

Operation

Basic operating rules

Once the equipment has been installed, follow the prescriptions set down in the previous pages and plug in the power cable, making sure the air receiver is empty by opening the drain valve (Fig. 1 - 2 - 3 - 4).



Once the receiver has been purged, close the valve.

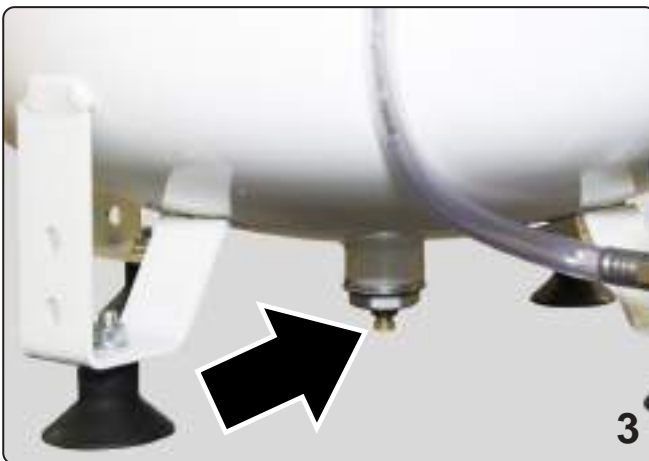
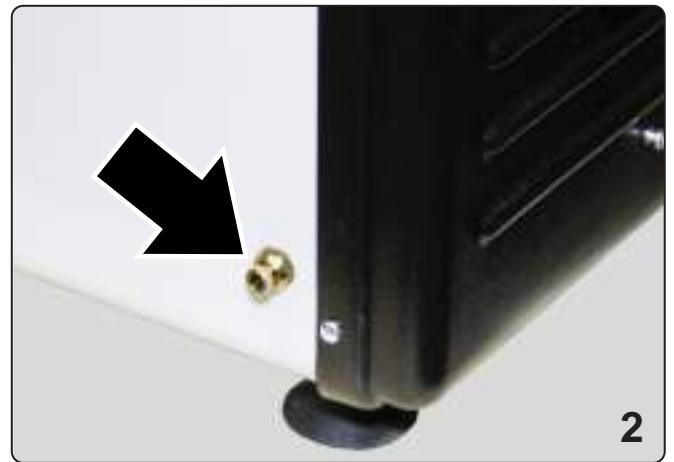

Now start the compressor by turning the switch or pressing the button (depending on the model, see Page 2-02 - Fig 1 - 2 - 3) located on the pressure switch (Fig. 1), except for the **TOP** model, on which the button is located on the front panel (Fig. 2).

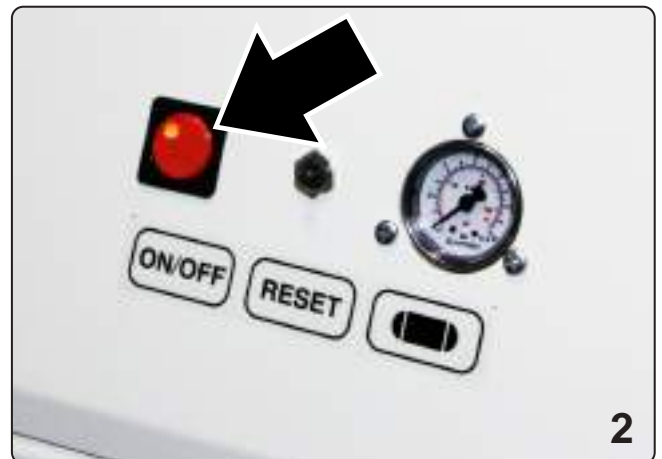
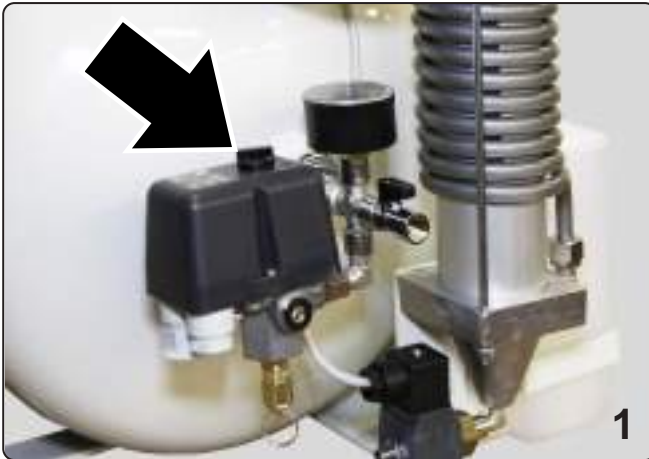

In the filling cycle the compressor reaches **8.5** bar.

At this point, close the line valve (Fig. 3 - 4 - 5 - 6) for around **30** minutes to check for possible internal leaks on the compressor.

Open the valve (Fig. 3 - 4 - 5 - 6), with the chair or laboratory connected and with no instruments operating, and check that the pressure reading on the gauge remains constant, thereby establishing the absence of air leaks in the circuit.

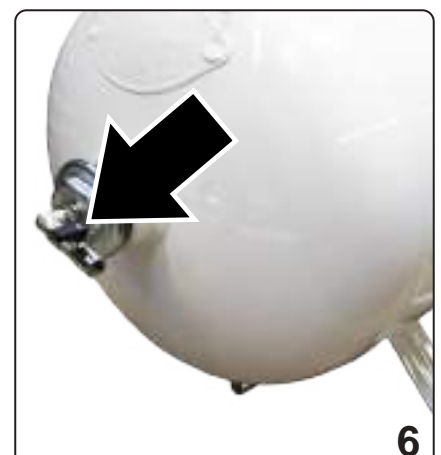
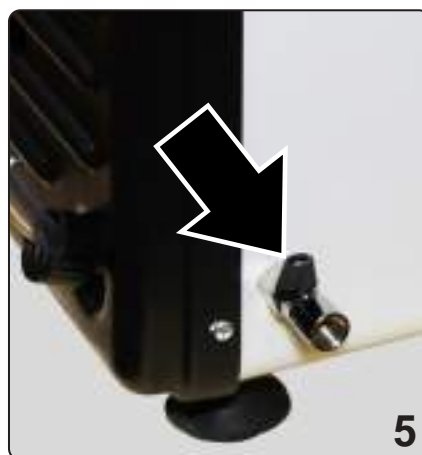



WARNING

- Compressor operation is regulated by pressure in the system: when the pressure falls below around **6 bar** the compressor will start automatically, shutting down automatically when the pressure reaches **8.5 bar**.
- At the end of each cycle all dryer-equipped compressors will emit a whistling noise produced by an air blast; this is due to the dryer's self-regeneration cycle and shows that the dryer is operating normally.

If the compressor continues filling for longer than the value shown in the following table, this is a sign of an air leak in the system or in the compressor.

In this case, switch off the compressor at the main power switch and call technical service.

FILLING TIMES				
REF	Minutes from 0 to 8.5 bar	Minutes from 6 to 8.5 bar	Minutes from 0 to 8.5 bar	Minutes from 6 to 8.5 bar
ECO3 25LT	1.07	0.16	1.12	0.22
ECO3 40LT	1.51	0.24	1.58	0.33
ECO3 50LT	2	0.35	2.08	0.48
MONSTER3	2	0.35	2,08	0.48
TOP3	1.25	0.15	1.3	0.21
ECOSIL3	2	0.35	2.08	0.48
ECO6	1.97	0.33	2.05	0.46
MONSTER6	2.97	0.7	3	1
ECO9	1.48	0.3	1.55	0.43
ECO2 25LT	1.12	0.23	1.16	0.25
ECO2 40LT	2.32	0.52	2.40	0.58
ECO2 50LT	3	1.05	3.10	1.15
MONSTER2	3	1.05	3.10	1.15
TOP2	1.52	0.35	1.58	0.39
ECOSIL2	3	1.05	3.10	1.15
ECO4	2.96	1.02	3.06	1.12
MONSTER4	4.35	1.44	4.50	1.59

Automatic thermal protector - Reset button

The compressors are equipped with an automatic thermal protector inside each motor (Fig. 1 and 2).

If the thermal protector trips, the compressor will stop and remain stopped until the motor internal temperature returns to normal.

If the thermal protector trips repeatedly, call technical service.

The **TOP** model is also equipped with an external overload circuit breaker.

In order to restart the compressor you must first press the **RESET** button (Fig. 3).

If the compressor continues to shut down due to tripping of the thermal protector or if it fails to restart even though the thermal protector has been reset, call technical service.

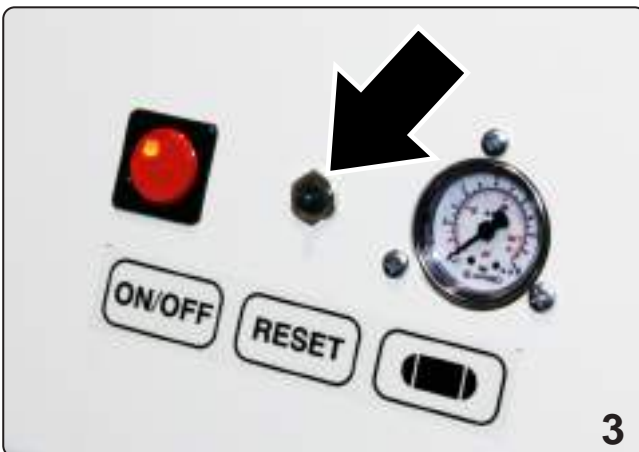
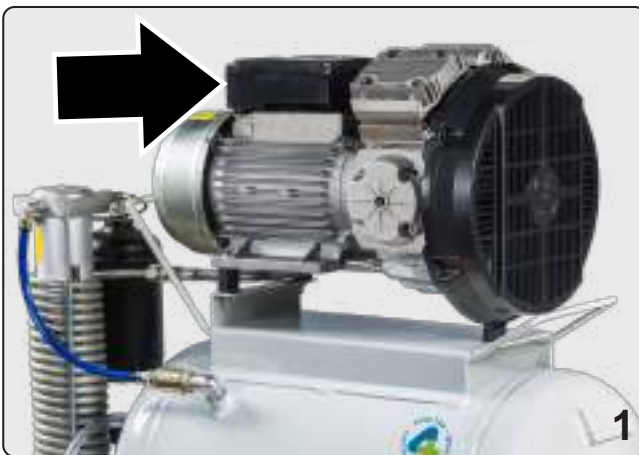

Maintenance

Safety precautions

Introduction

The compressor maintenance technician must be properly trained and have a detailed knowledge of the applicable safety regulations.

Qualification of maintenance technicians

The composition and skills of the teams indicated in the maintenance plan are as prescribed by **4tek S.r.l.**



Maintenance Mechanic

A qualified technician capable of working on mechanical parts to perform all adjustment, maintenance, and repair tasks.



Maintenance Electrician

A qualified technician capable of performing all electrical adjustment, maintenance and repair tasks.

Competences of qualified personnel

To meet the requirement for ever increasing skill levels in the field of maintenance on automated equipment, maintenance personnel must:

- be aware of the directives in force concerning injury prevention during work performed on motor-driven equipment and be capable of applying them.
- know how to use and consult the manufacturing documentation and instructions.

Specific safety precautions

Before commencing any maintenance work, put on suitable protective gloves.

Before proceeding with maintenance operations, pay careful attention to the following warnings:

- The maximum reliability of the compressor and the lowest possible maintenance cost are obtained by following a planned and scrupulously executed maintenance and inspection programme throughout its entire life.
Abide strictly by the maintenance intervals established, and schedule the operations taking into account the specific needs associated with the compressor production cycle.
- Remember to switch off the compressor when the dental surgery is closed, to prevent it from starting unnecessarily and continuing to fill the air receiver due to possible air leaks in the dental surgery.

This could lead to breakage of the compressor due to motor overload.



- If major repair work must be carried out always consult **4tek S.r.l.**
- The equipment carries voltages that can kill on contact.
Proceed with the utmost caution at all times and comply strictly with statutory safety regulations.
- Always disconnect the main compressor power supply before carrying out maintenance.
- Do not use flammable or toxic solvents such as petrol, benzene, ether, and alcohol.
- Avoid prolonged contact with solvents and do not inhale solvent vapours.
Do not use solvents near naked flames or heat sources; ensure sufficient ventilation.
- Prolonged overloads or malfunctions can cause electric motors to overheat.
- Never use water jets to extinguish electrical fires; disconnect all compressor power supplies and use **CO2** fire extinguishers.

Routine maintenance

Compressors without Dryer

Drain off condensate at least once a week by opening the drain valve on the receiver (Fig. 1 for **ECO** [50 l vertical receiver - 40 l or 25 l receiver] and **MONSTER** Models) - (Fig. 2 for **ECO** 50 l horizontal Models) - (Fig. 3 for **TOP** Models) - (Fig. 4 for 100 or 150 l Models).

Once the receiver has been purged, close the valve.

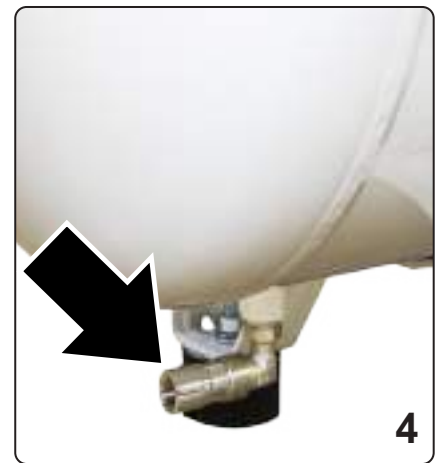
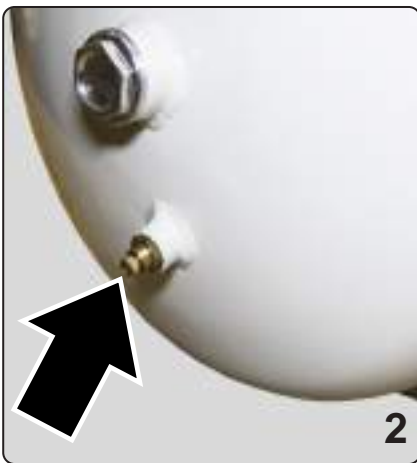
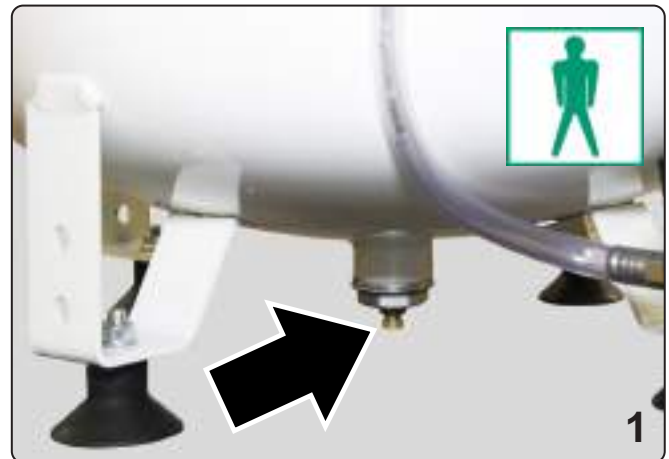

Compressors with Dryer

Empty the condensate drain bottle (Fig. 5) once a week: remove the bottle from its support after having unscrewed the cap; the water it contains is uncontaminated and can be poured into any normal drain. Reinstall the bottle and refit the cap.



IMPORTANT

When reinstalling the bottle make sure the two "overflow holes" are facing outwards and not towards the compressor to prevent condensate from reaching and damaging the solenoid valve.

Check for the presence of condensate in the air receiver at least once every three months by opening the drain valve on the receiver (Fig. 1 - 2 - 3 - 4).

If the receiver contains condensate, this means that dryer is not functioning correctly or the compressor is undersized for the application, so the air flow is insufficient for the Dryer self-regeneration cycle.



Major servicing



- The check must be carried out periodically, at a frequency that depends on the dental surgery's workload.
- For a dental surgery working eight hours/day five days/week if the compressor is monitored also by the dental surgery routine maintenance person, it is sufficient to arrange a service visit once every six or twelve months.
- The major servicing: technician must use exclusively genuine original parts and must not alter the compressors or their operation or tamper with the safety systems.
- Do not weld the compressor air receiver.
- Before starting work, read the Instruction Manual and any other relevant documentation (exploded views, parts lists, wiring diagrams) in the reserved area of our website **www.4-tek.it**.
- Before carrying out maintenance work on the compressor, disconnect the electrical supply.
- Make sure that the compressor reaches the maximum control pressure after each filling cycle and check that the filling times are as shown in the table on page 5-03.
- Check electrical power consumption in accordance with the values shown on the product label.
- When the compressor starts with difficulty, check the mains voltage and the capacitance of the capacitor (check the rating data).
- A change in running noise or excessive vibration of the compressor can be a sign of a fault and the risk of breakdown.
- Check that the plant room temperature is no higher than 40°C: compressor operation may be impaired in higher ambient temperatures.
- Check to ensure there is no water in the receiver.
- Check to ensure routine maintenance operations are performed correctly; if they are not, inform the equipment owner of the importance of maintenance to keep the compressor in good working order.
- Change the air-intake filter at least once a year (Fig. 1).



- If the unit is fitted with a **HEPA14** filter (Fig. 1), change it in accordance with the prescriptions of the filter User Manual.
- For compressors equipped with a dryer, it is essential to service the dryer:
 - Once a year turn the drying column upside down.
 - Replace the drying column 2 years from the date of purchase (Fig. 2).

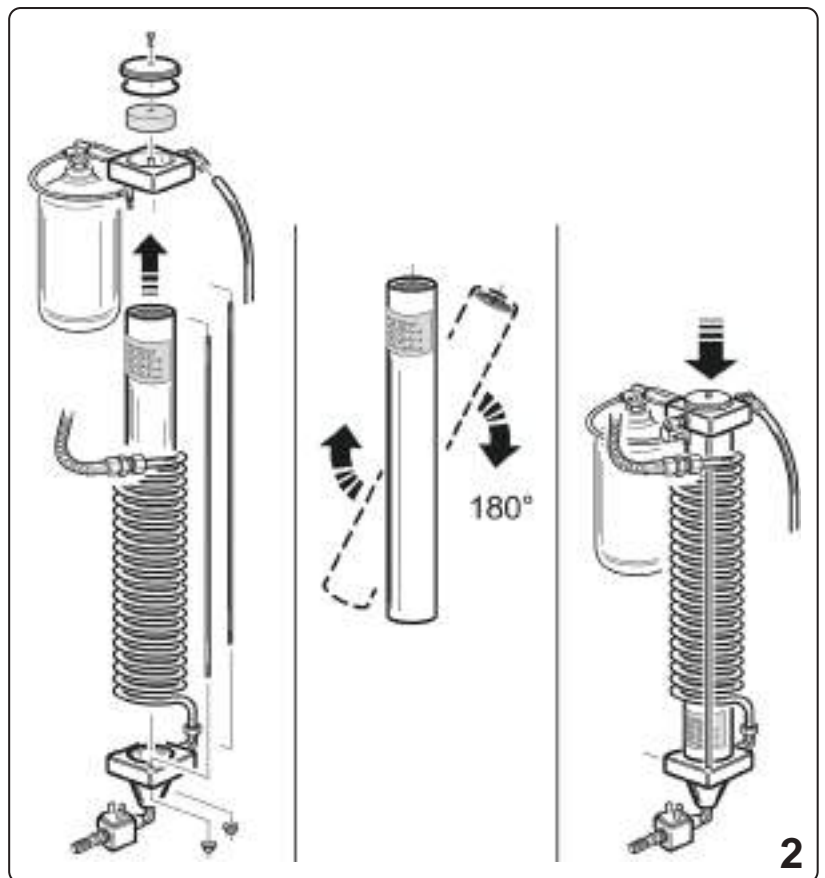

WARNING

In compliance with the national legislation in your country, carry out the required safety checks including:

- Check the safety valve and replace it if necessary
- Use the necessary instruments to check the thickness of the receiver walls
- Electrical safety test



Troubleshooting

Problem

Compressor does not start.

Cause

- Mains power loss.
- Overvoltage or undervoltage.
- Pressure switch has not closed.
- Motor internal thermal protector has tripped.
- Overload circuit breaker has tripped (only for the **TOP** line).
- Capacitor discharged.

Solution

- Check the dental surgery or laboratory circuit breaker.
- Measure mains voltage and call the electrician if necessary.
- Connect pressure switch (See Fig. 1 - 2 Page 5-02).
- Allow the compressor to cool down.
- Reset the thermal protector (See Fig. 3 on Page 5-04).
- Replace the capacitor.

Motor hum.

Faulty motor capacitor.

Replace the capacitor.

Compressor runs continuously, but does not fill the receiver.

- Compressor is undersized with respect to the air demand of the dental surgery or laboratory.
- Air leak in the system tubing.
- Failure of a gasket or a valve plate, or worn piston rings.
- Solenoid valve burnt out (if dryer present).

- Establish the compressed air demand of the dental surgery (approximately 60 l/min per chair) or of the laboratory and use a more powerful compressor if necessary.
- Find and repair leaks.
- Change gasket or valve plate or piston rings (See Pages 9-01 to 9-05).
- Replace the solenoid valve (If Dryer present).

Compressor does not fill up to 8 bar.

- Dirty non-return valve.
- One of the gaskets or valve plates has failed.

- Discharge the receiver pressure, unscrew the valve and clean it (See Fig. 5 or 7 on Page 2-02).
- Replace the gasket or valve plate (See pages 9-01 to 9-05).

Noise of air escaping from the pressure switch valve or the dryer solenoid valve when compressor is not running.

Dirty non-return valve.

Discharge the receiver pressure, unscrew the non-return valve (See Fig. 5 or 7 on page 2-02) and clean it.
If the problem persists, replace the valve.



Problem

Compressor switches on periodically even though the system is not consuming any air.

Loud metallic hammering noise.

Compressor does not fill, motor seems to stop, heads are not all at same temperature, with one or more cold heads.

Compressor filling cycles are much shorter than indicated in the "Filling times" table.

Compressor filling cycles are much longer than indicated in the "Filling times" table.

Cause

Air leak in system tubing.

Damaged cylinder head.

Failure of one or more valve plates.

Condensate in the air receiver.

- Dirty air-intake filter.
- Worn piston rings.

Solution

Find and repair the leak.

Disconnect power and contact technical service.

Replace broken valve plates. (See Pages **9-01** to **9-05**)

- Empty the receiver by opening the drain valve (See Figs. **1 - 2 - 3 - 4** on Page **5-01**), contact technical service if the problem persists.
- Change the air-intake filter (See Fig. **1** on Page **6-04**) once a year (as indicated in the "Major Servicing" Section).
- Change the piston rings (See Pages **9-01** to **9-05**).



Disposal



IMPORTANT

Plastic and metal components can be recycled.



A crossed-out wheellie bin symbol displayed on the equipment means the product must be disposed of separately from other waste at the end of its useful life.



- The manufacturer organises and manages sorted waste collection of the equipment at the end of its useful life.
- If users wish to scrap the equipment they should contact the manufacturer and follow the manufacturer's practices for separate collection of decommissioned products.
- Adequate sorted collection and disposal of decommissioned equipment helps to avoid possible negative impacts on the environment and on health and promotes reuse and/or recycling of the equipment construction materials.
- Unauthorised disposal of the product by the user is punishable by legally defined administrative penalties.



Warranty

If installed properly and correctly sized in accordance with the dental surgery, **4TEK S.r.l.** compressors are guaranteed for 24 months from the date of shipment and anyway for no more than **36** months from the date of issue of the **4TEK** invoice.

To validate the warranty, the Customer must (within **30** days from the date on which the defect is noted) inform **4TEK S.r.l.** in writing by sending an email to one of the following addresses:

- **stefano@4-tek.it**
- **riccardo@4-tek.it**
- **gabriella@4-tek.it**

or the **Area Representative**.

In any case, note that the cost of transporting the compressor to be repaired will be borne by the customer and is not included in the cost of repair.

The warranty does not cover defects caused by incorrect maintenance, negligence, and/or accidental transport damage.

4TEK S.r.l. cannot be held liable for problems associated with compressor downtimes, interruption of treatments, loss of income, or any damage to property and/or injury to persons.

This warranty can be modified only by **4TEK S.r.l.**

Exploded views and spare parts tables

How to order replacement parts

Use the following procedure to order replacement parts:

- Find the required part and its number on the drawings on Page 9-02 or 9-04.
- Check the code, description and quantity against the part number in the table on page 9-03 or 9-05.

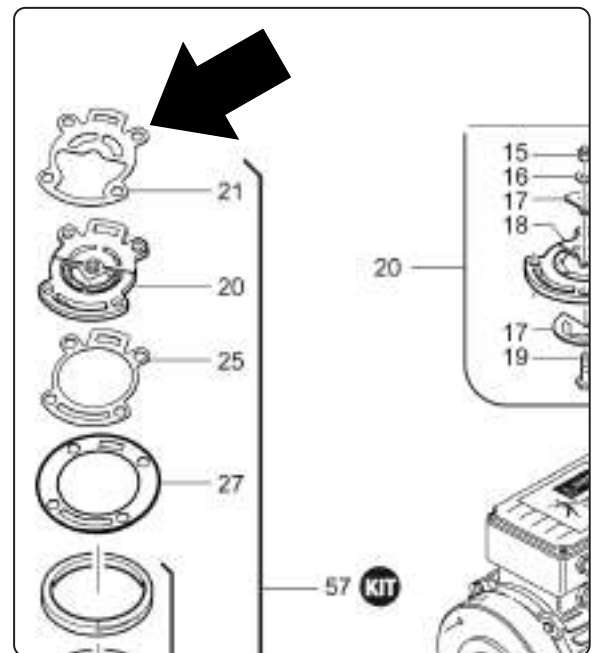

19		VITE	SCREW	VIS	1
20	ECO000022	PIASTRA VALVOLA COMPLETA	COMPLETE VALVE PLATE	PLAQUE DE LA SOUPAPE COMPL.	3
21	ECO000034	GUARNIZ. PIASTRA-TESTA	GASKET VALVE PLATE-HEAD	JOINT PLAQUE-TETE	3
22	ECO000058	VITE TCCE M8x65 mm	SCREW	VIS	12
23	CO2000020	RONDELLA DENTATA M8	TOOTHED WASHER	RONDELLE DENTÉE	12

Fill in the order as follows:

Part no. in drawing	Code	Description	Quantity
21	ECO000034	HEAD PLATE GASKET	3

Exploded views and spare parts tables

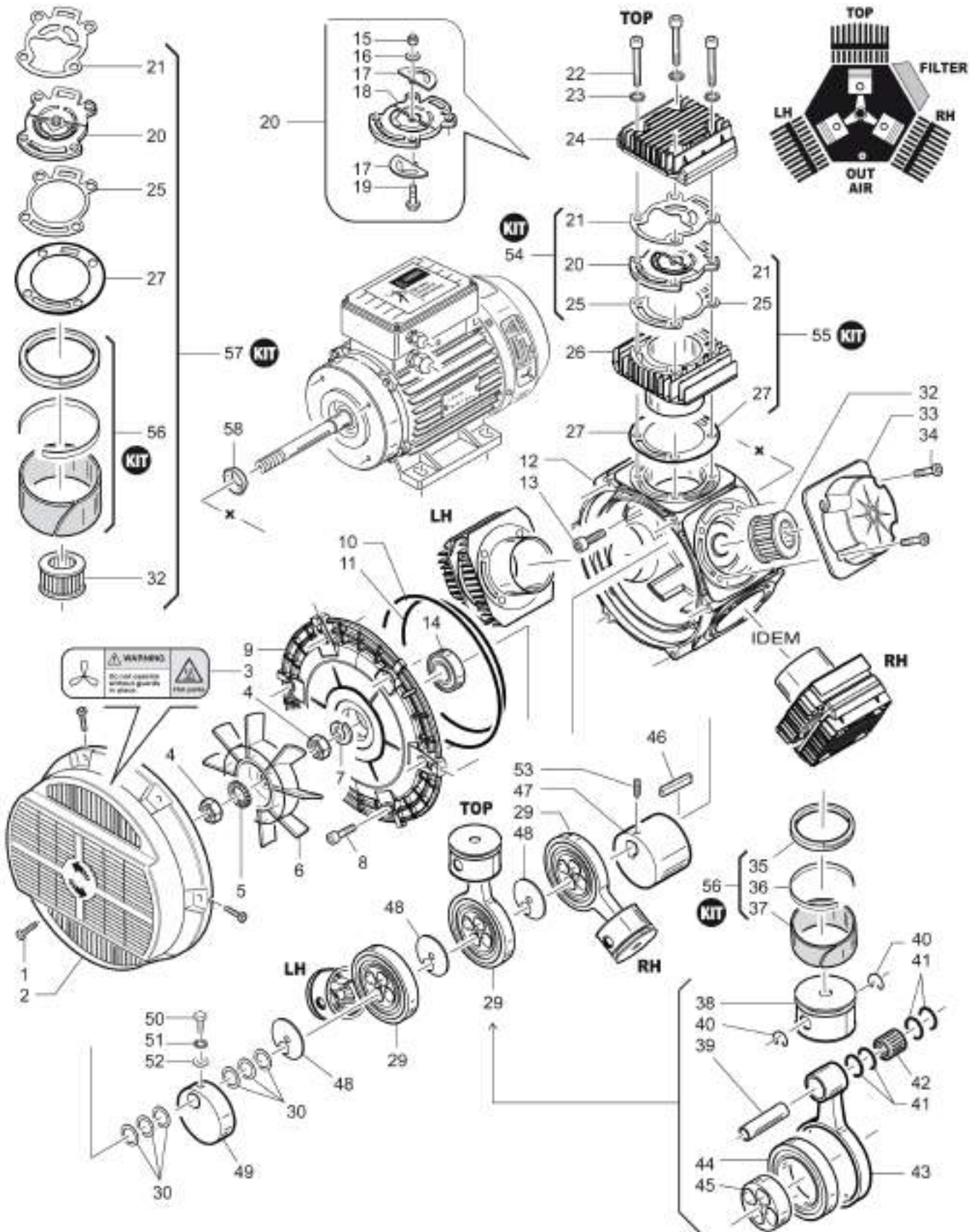



POS.	CODE	DESCRIZIONE	DESCRIPTION	DESCRIPTION	Q.TY
1	ECO000062	VITE TC M6x30 mm	SCREW	VIS	3
2	ECO000031	COPRIVENTOLA	FAN COVER	COUVERCLE DU VENTILATEUR	1
3	CO1800005	ETICHETTA (WARNING)	LABEL (WARNING)	ETIQUETTE (WARNING)	1
4	ECO000069	DADO M16 BASSO	NUT MIG	ÉCROU	2
5	COMI00074	ROND. DENTATA Ø16 mm	WASHER	RONDELLE	1
6	ECO000046	VENTOLA	FAN	VENTILATEUR	1
7	COMI00033	RONDELLA GROWER	GROWER WASHER	RONDELLE GROWER	1
8	ECO000064	VITE TCCE M8x30 mm	SCREW	VIS	3
9	ECO000079	COPERCHIO CARTER	CASING COVER	COUVERCLE DU CARTER	1
10	ECO000037	O-RING SUPERIORE 3725	O-RING	O-RING	1
11	ECO000036	O-RING INFERIORE 3600	O-RING	O-RING	1
12	ECO000120	CARTER	CARTER	CARTER	1
13	ECO000161	VITE TCCE M8x40 mm	SCREW	VIS	4
14	COMI00006	CUSCINETTO 6303 2RS	BEARING	ROULEMEN	1
15		DADO	NUT	ÉCROU	1
16		RONDELLA	WASHER	RONDELLE	1
17		LAMELLA	SMALL PLATE	PLAQUETTES	2
18		PIASTRA	PLATE	PLAQUE	1
19		VITE	SCREW	VIS	1
20	ECO000022	PIASTRA VALVOLA COMPLETA	COMPLETE VALVE PLATE	PLAQUE DE LA SOUPAPE COMPL.	3
21	ECO000034	GUARNIZ. PIASTRA-TESTA	GASKET VALVE PLATE-HEAD	JOINT PLAQUE-TETE	3
22	ECO000058	VITE TCCE M8x65 mm	SCREW	VIS	12
23	CO2000020	RONDELLA DENTATA M8	TOOTHED WASHER	RONDELLE DENTÉE	12
24	ECO000023	TESTINA CILINDRO	CYLINDER HEAD	TETE DU CILINDRE	3
25	ECO000033	GUARNIZIONE CIL. PIASTRA	GASKET CYL.VALVE PLATE	JOINT CILINDRE-PLAQUE	3
26	ECO000021	CILINDRO	CYLINDER	CILINDRE	3
27	ECO000032	GUARNIZ. CIL. CARTER	GASKET CYL.-CARTER	JOINT CILINDRE-CARTER	3
29	ECO000114	IMBIELLAGGIO COMPLETO	CONNECTING ROD SYSTEM	COMPLETE IMBIELLAGE	3
30	ECO000068	DISTANZIALE	SPACER	ESPACEMENT	6
32	ECO000056	FILTRO IN CARTA	PAPER FILTER	FILTRE EN PAPIER	1
33	ECO000024	COPERCHIO FILTRO	FILTER COVER	COUVERCLE DU FILTRE	1
34	ECO000057	VITE TCCE M8x20 mm	SCREW	VIS	6
35	ECO000038	SEGMENTO COMPRESS.	COMPRESSION RING	SEGMENT	3
36	ECO000039	ANELLO ESPANSIONE	SPRING FOR COMPR. RING	BAGUE D'EXPANSION	3
37	ECO000155	FASCIA	GUIDE BAND	BANDE DE GUIDAGE	3
38	ECO000027	PISTONE	PISTON	PISTON	3
39	ECO000051	SPINOTTO	PIN	PISTON PIN	3
40	ECO000047	ANELLO ELASTICO	ELASTIC RING	BAGUE ÉLASTIQUE	6
41	ECO000035	PARAGRASSO	SEAL	JOINT	12
42	ECO000050	BOCCOLA A RULLINI	FERRULE	DOUILLE	3
43	ECO000005	BIELLA Ø80 mm	CONNECTING ROD	BIELLE	3
44	ECO000052	CUSCINETTO 6010 C3 ZZ	CONNECTING ROD BEARING	ROULEMENT DE BIELLE	3
45	ECO000207	ECCENTRICO BIELLA	CAM	CAME	3
46		CHIAVETTA	KEY	CLLAVETTE	1
47	ECO000214	ECCENTRICO	CAM	CAME	1
48	ECO000068	DISTANZIALE	SPACER	ESPACEMENT	3
49	ECO000094	CONTRAPPESO	COUNTERWEIGHT	CONTREPOIDS	1
50	CO2000004	VITE TE M6x12 mm	SCREW	VIS	1
51	CO2000018	RONDELLA DENTATA Ø6 mm	TOOTHED WASHER	RONDELLE DENTÉE	1
52	CO2000060	RONDELLA Ø6 mm	WASHER	RONDELLE	1
53	ECO000081	GRANO M6x14 mm	DOWEL	GOUJON	1
54	KITVLVPLT	KIT PIASTRA VALVOLA	VALVE PLATE KIT	KIT PLAQUE DE LA SOUPAPE	
55	KITGKTVLVECO	KIT GUARNIZIONE	GASKET KIT	KIT JOINT	
56	KITCMPECO	KIT FASCE ELASTICHE	GUIDE BAND KIT	KIT BANDE DE GUIDGE	
57	KITMNTTECO	KIT MANUTENZIONE	MINTENNCE KIT	KIT DE MAINTENANCE	
58	ECO000212	RONDELLA CONICA	CONICAL WASHER	RONDELLE CONIQUE	1



POS.	CODE	DESCRIZIONE	DESCRIPTION	DESCRIPTION	Q.TY
1	ECO000062	VITE TC M6x30 mm	SCREW	VIS	3
2	ECO000031	COPRIVENTOLA	FAN COVER	COUVERCLE DU VENTILATEUR	1
3	CO1800005	ETICHETTA (WARNING)	LABEL (WARNING)	ETIQUETTE (WARNING)	1
4	ECO000069	DADO M16 BASSO	NUT MIG	ÉCROU	2
5	COMI00074	ROND. DENTATA Ø16 mm	TOOTHED WASHER	RONDELLE DENTÉE	1
6	ECO000046	VENTOLA	FAN	VENTILATEUR	1
7	COMI00033	ROND. GROWER 16x27x3	GROWER WASHER	RONDELLE GROWER	1
8	ECO000064	VITE TCCE M8x30 mm	SCREW	VIS	3
9	ECO000079	COPERCHIO CARTER	CASING COVER	COUVERCLE DU CARTER	1
10	ECO000037	O-RING SUPERIORE 3725	O-RING	O-RING	1
11	ECO000036	O-RING INFERIORE 3600	O-RING	O-RING	1
12	ECO000187	CARTER	CARTER	CARTER	1
13	ECO000161	VITE TCCE M8x40 mm	SCREW	VIS	4
14	COMI00006	CUSCINETTO 6303 2RS	BEARING	ROULEMEN	1
15		DADO	NUT	ÉCROU	1
16		RONDELLA	WASHER	RONDELLE	1
17		LAMELLA	SMALL PLATE	PLAQUETTES	2
18		PIASTRA VALV.	VALVE PLATE	PLAQUE DE LA SOUPE	1
19		VITE	SCREW	VIS	1
20	ECO000022	PIASTRA VALVOLA COMPLETA	COMPLETE VALVE PLATE	PLAQUE DE LA SOUPE COMPL.	2
21	ECO000034	GUARNIZ. PIASTRA-TESTA	GASKET VALVE PLATE-HEAD	JOINT PLAQUE-TETE	2
22	ECO000058	VITE TCCE M8x65 mm	SCREW	VIS	8
23	CO2000020	RONDELLA DENTATA M8	TOOTHED WASHER	RONDELLE DENTÉE	8
24	ECO000023	TESTINA CILINDRO	CYLINDER HEAD	TETE DU CILINDRE	2
25	ECO000033	GUARNIZIONE CIL. PIASTRA	GASKET CYL.VALVE PLATE	JOINT CILINDRE-PLAQUE	2
26	ECO000021	CILINDRO	CYLINDER	CILINDRE	2
27	ECO000032	GUARNIZ. CIL. CARTER	GASKET CYL.-CARTER	JOINT CILINDRE-CARTER	2
28	ECO000212	RONDELLA CONICA	CONICAL WASHER	RONDELLE CONIQUE	1
29	ECO000114	IMBIELLAGGIO COMPLETO	CONNECTING ROD SYSTEM	COMPLETE IMBIELLAGE	2
30	ECO000068	DISTANZIALE	SPACER	ESPACEMENT	2
31	ECO000153	BOCCOLA	FERRULE	DOUILLE	1
32	ECO000056	FILTRO IN CARTA	PAPER FILTER	FILTRE EN PAPIER	1
33	ECO000024	COPERCHIO FILTRO	FILTER COVER	COUVERCLE DU FILTRE	1
34	ECO000057	VITE TCCE M8x20 mm	SCREW	VIS	4
35	ECO000038	SEGMENTO COMPRESS.	COMPRESSION RING	SEGMENT	2
36	ECO000039	ANELLO ESPANSIONE	SPRING FOR COMPR. RING	BAGUE D'EXPANSION	2
37	ECO000155	FASCIA	GUIDE BAND	BANDE DE GUIDAGE	2
38	ECO000027	PISTONE	PISTON	PISTON	2
39	ECO000051	SPINOTTO	PIN	PISTON PIN	2
40	ECO000047	ANELLO ELASTICO	ELASTIC RING	BAGUE ÉLASTIQUE	4
41	ECO000035	PARAGRASSO	SEAL	JOINT	8
42	ECO000050	BOCCOLA A RULLINI	FERRULE	DOUILLE	2
43	ECO000005	BIELLA Ø80 mm	CONNECTING ROD	BIELLE	2
44	ECO000052	CUSCINETTO 6010 C3 ZZ	CONNECTING ROD BEARING	ROULEMENT DE BIELLE	2
45	ECO000207	ECCENTRICO BIELLA	CAM	CAME	2
54	KITVLVPLT	KIT PIASTRA VALVOLA	VALVE PLATE KIT	KIT PLAQUE DE LA SOUPE	
55	KITGKTVLVECO	KIT GUARNIZIONE	GASKET KIT	KIT JOINT	
56	KITCMPECO	KIT FASCE ELASTICHE	GUIDE BAND KIT	KIT BANDE DE GUIDGE	
57	KITMNTeco	KIT MANUTENZIONE	MINTENNCE KIT	KIT DE MAINTENANCE	